

- DO NOT SCALE DRAWING.
- ENGLISH PROVISIONS ARE STATED.
- DIMENSIONS ARE IN INCHES UNLESS OTHERWISE SPECIFIED.
- IF IN DOUBT ABOUT THE CORRECT METHOD OF CONSTRUCTION, REFER TO THE DRAWING OFFICE.

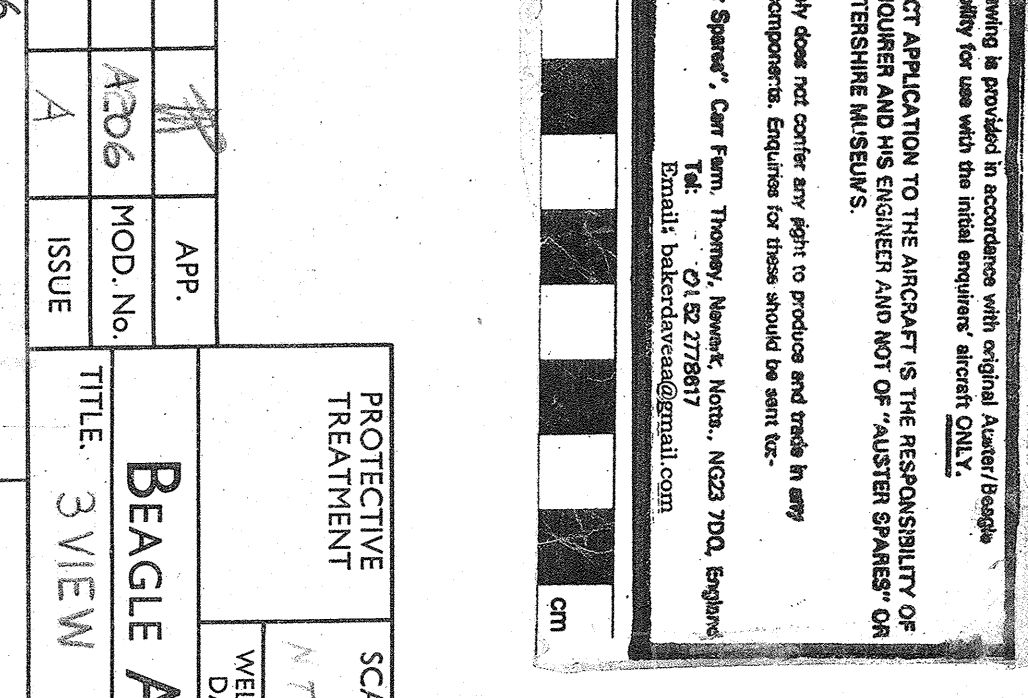
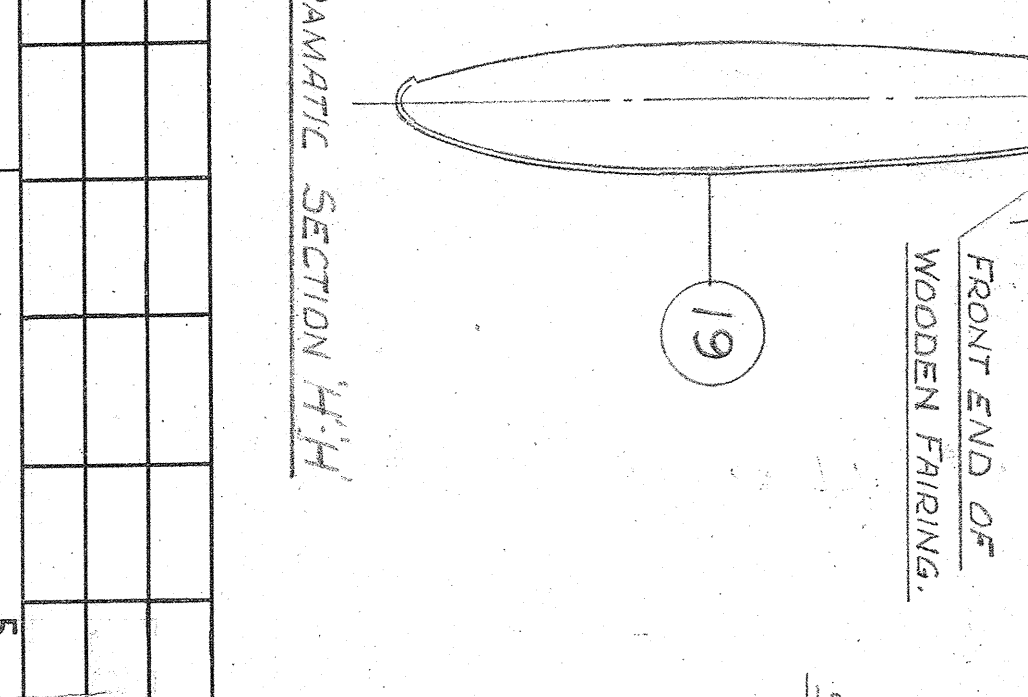
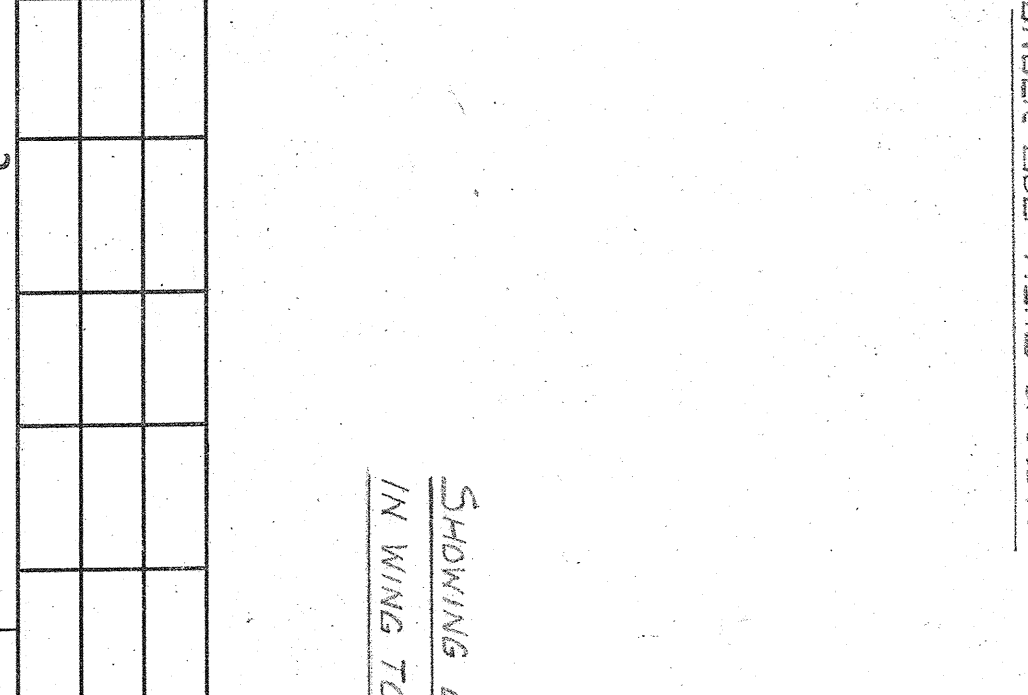
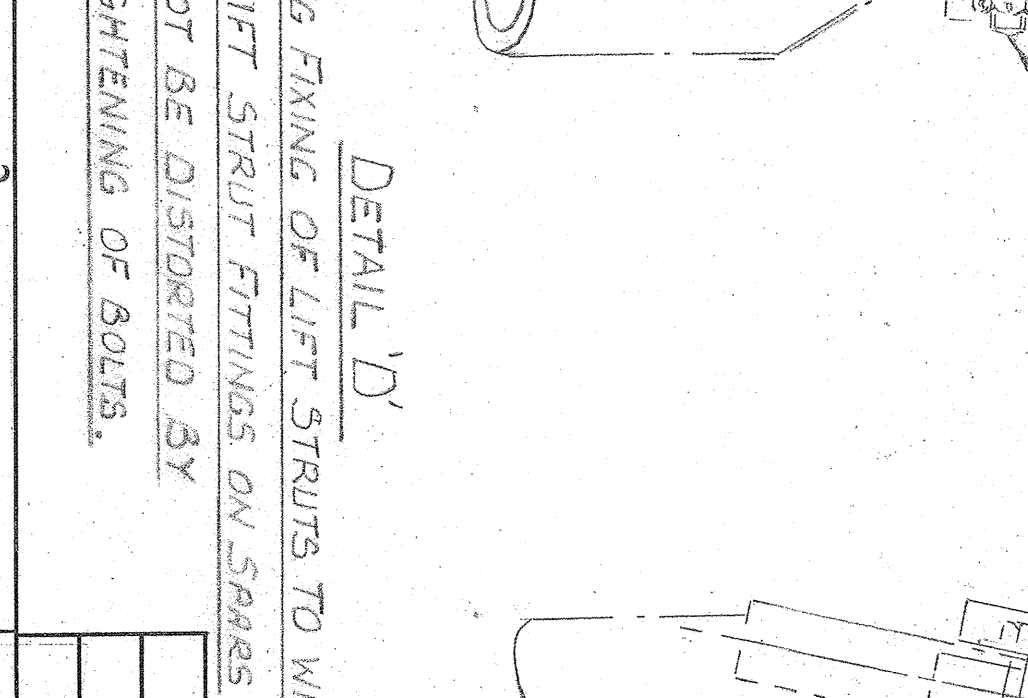
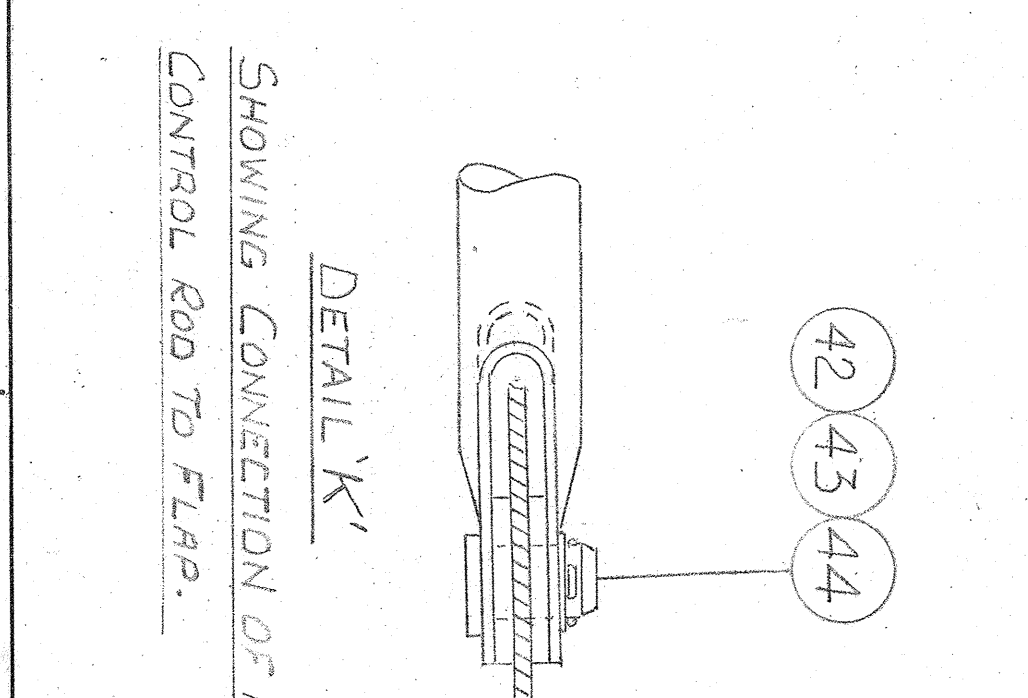
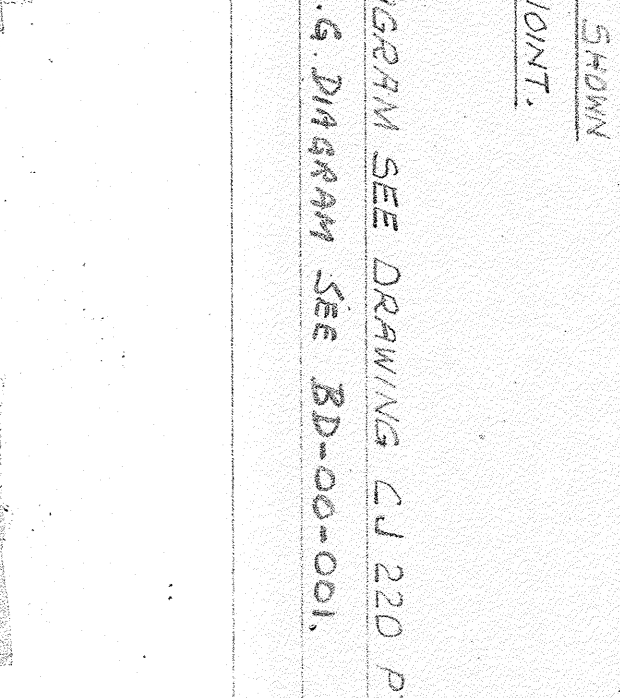
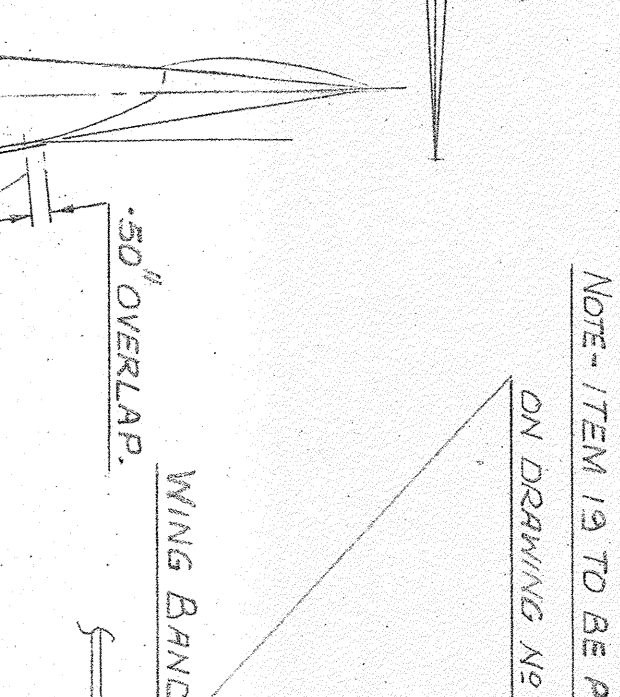
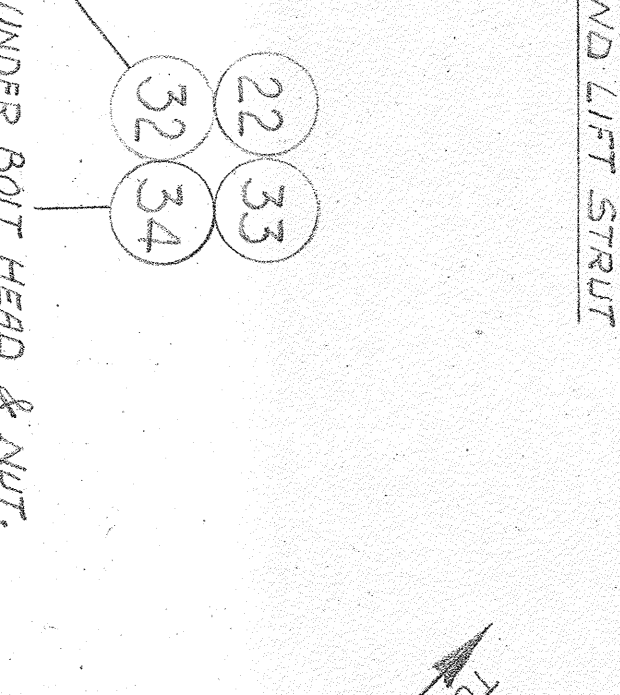
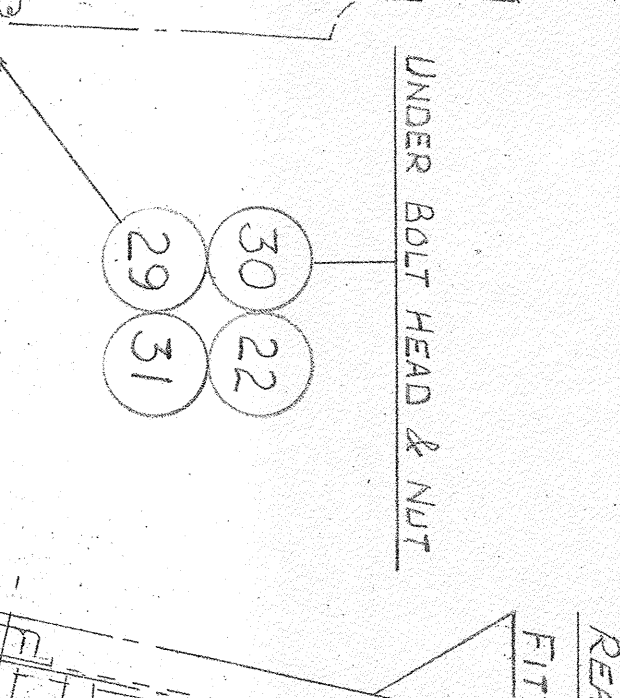
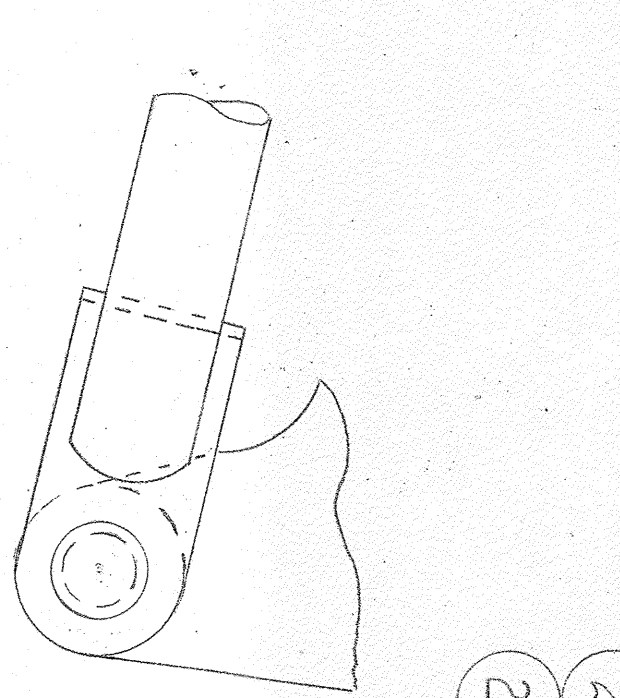
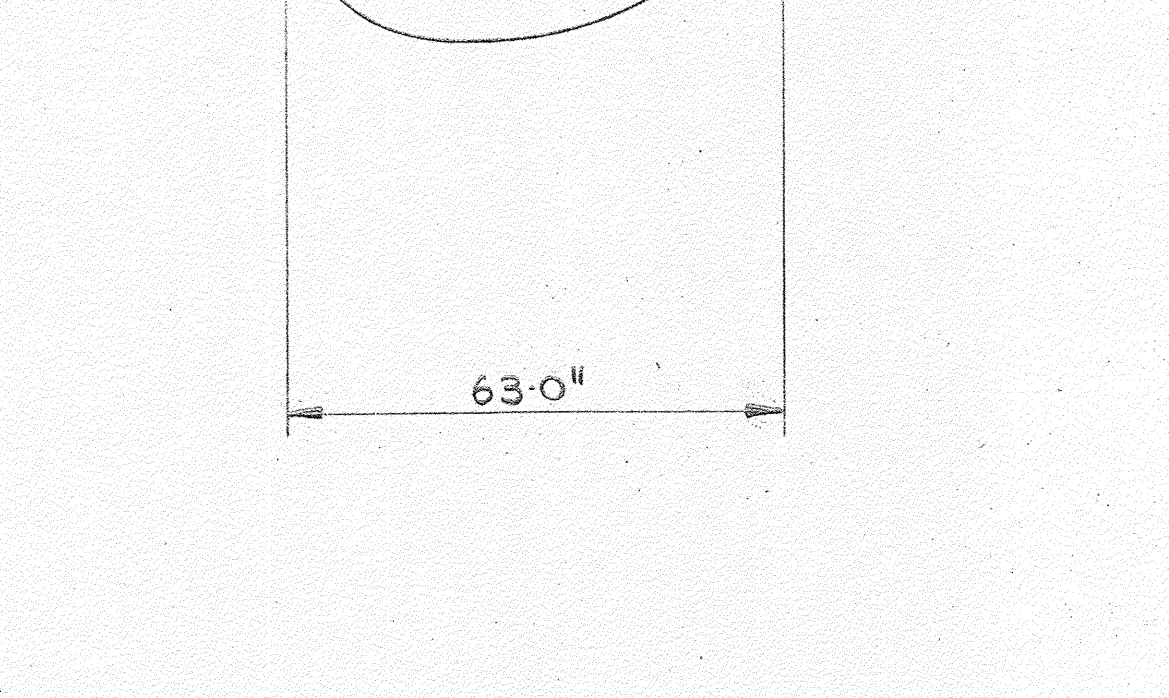
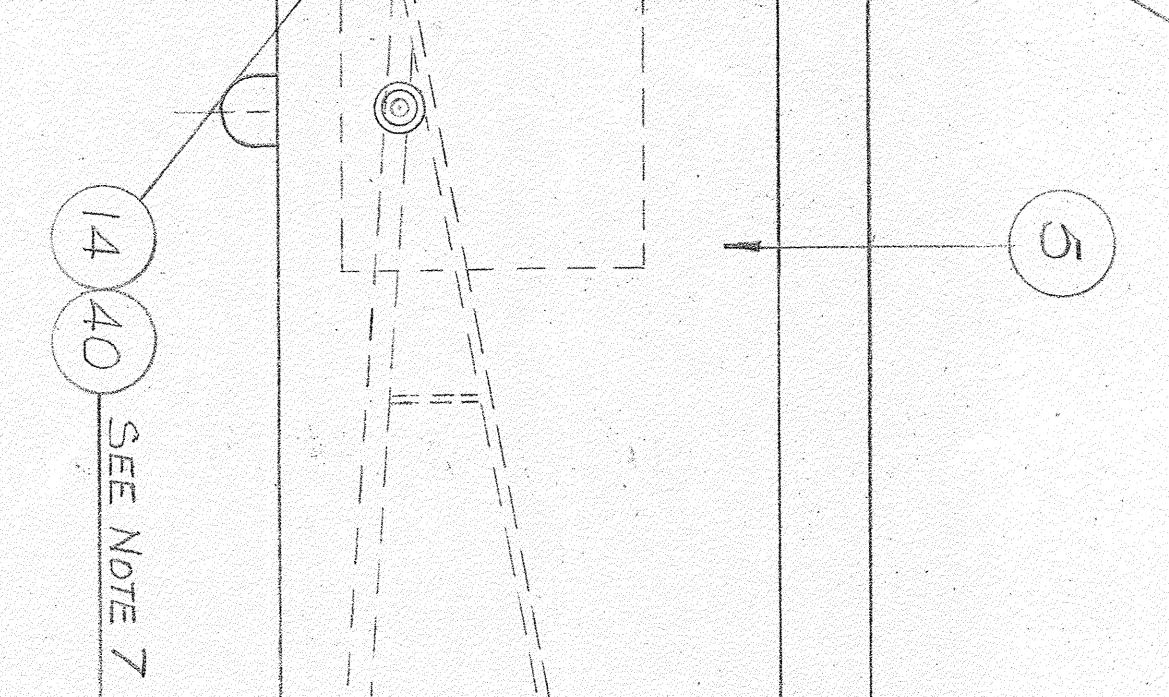
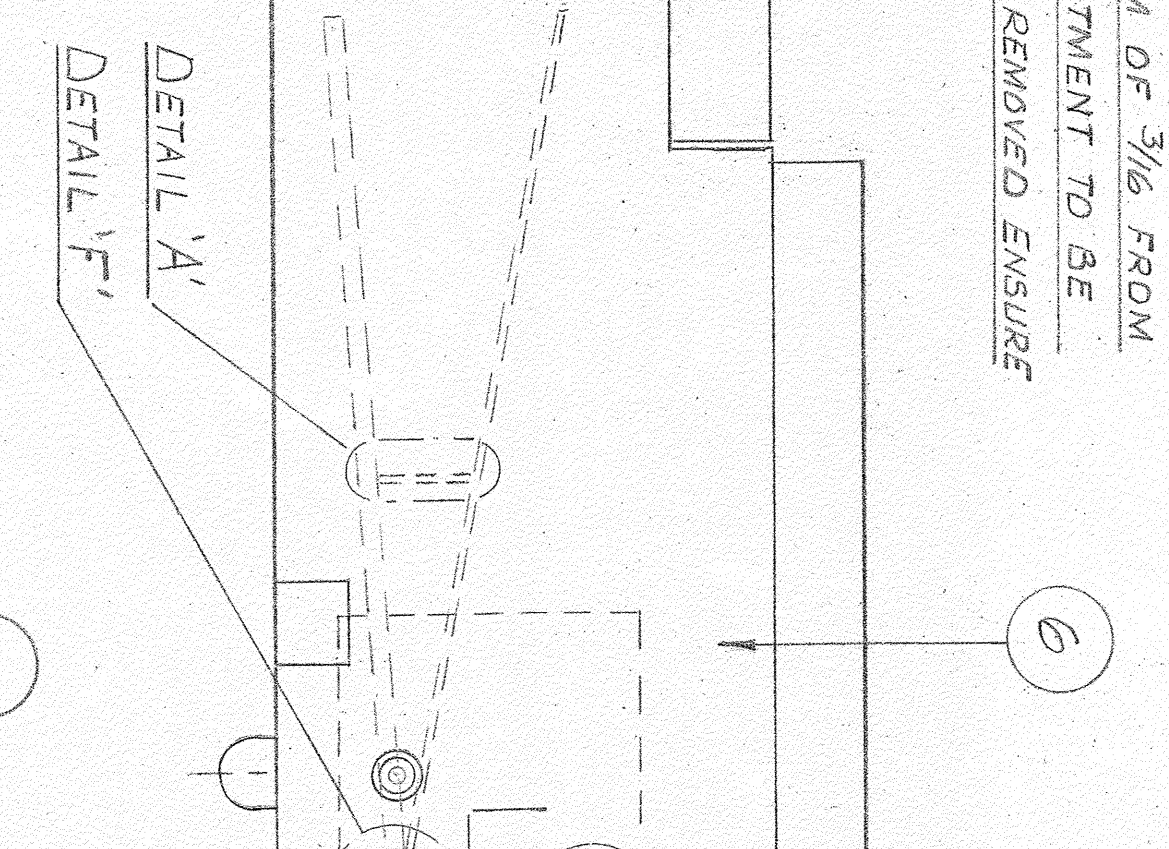
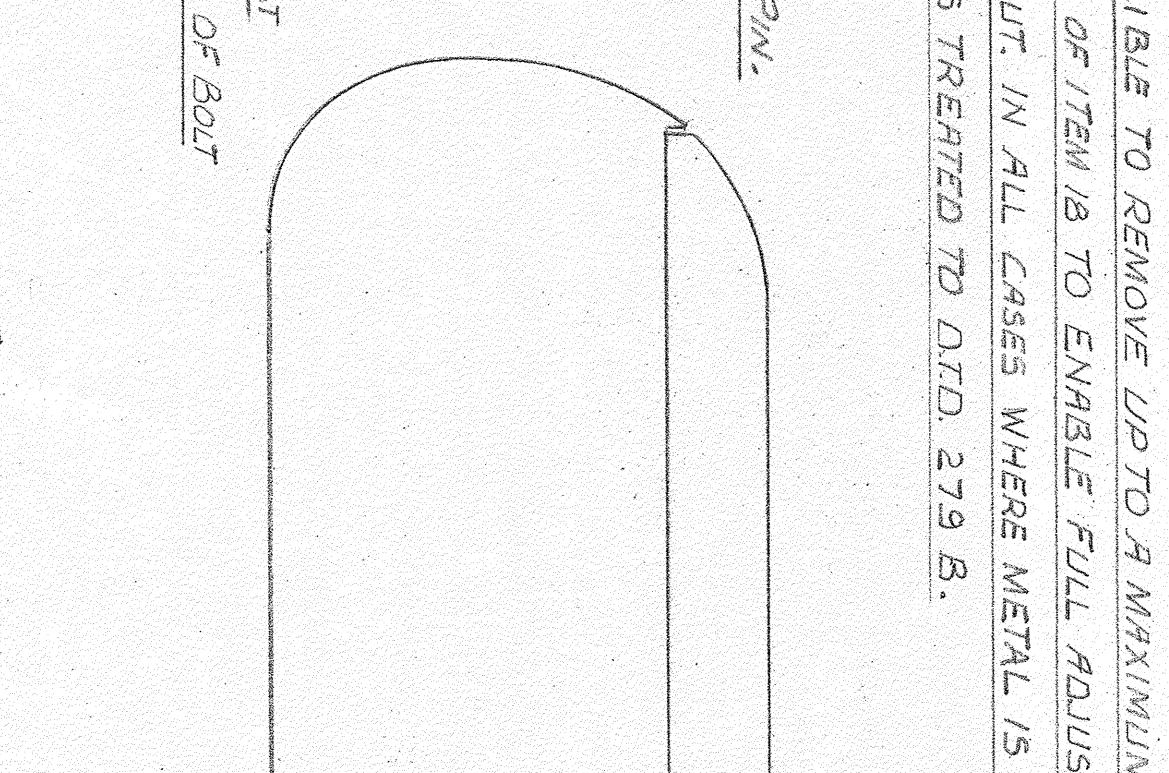
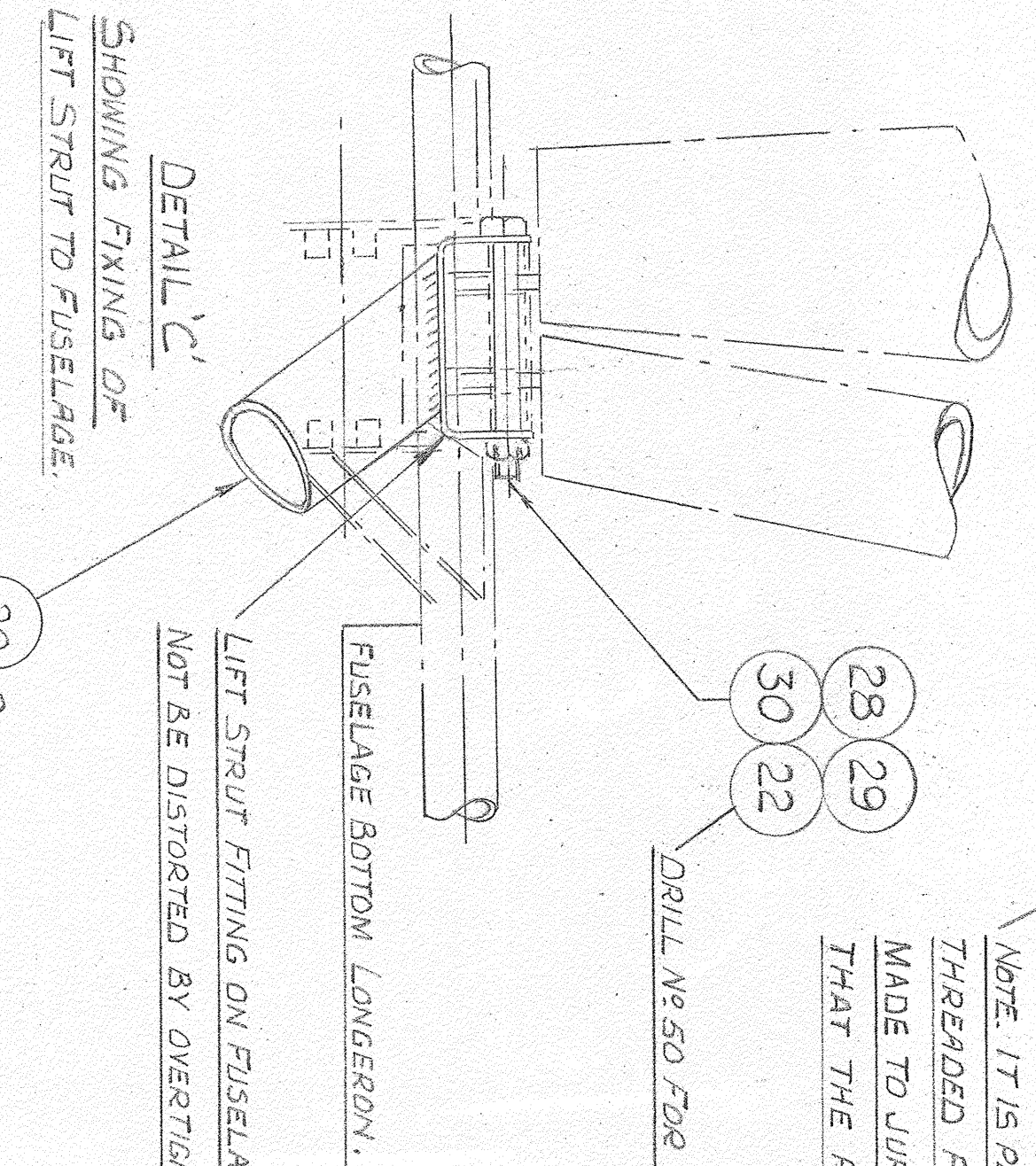
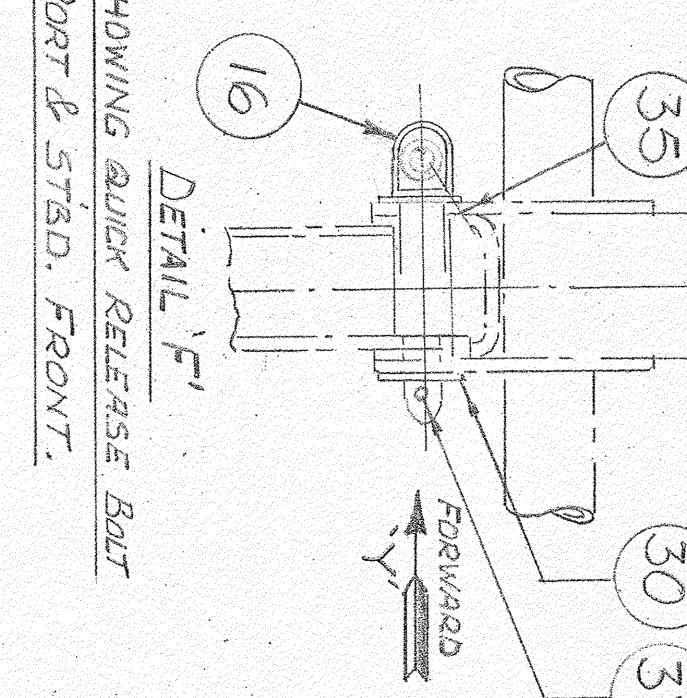
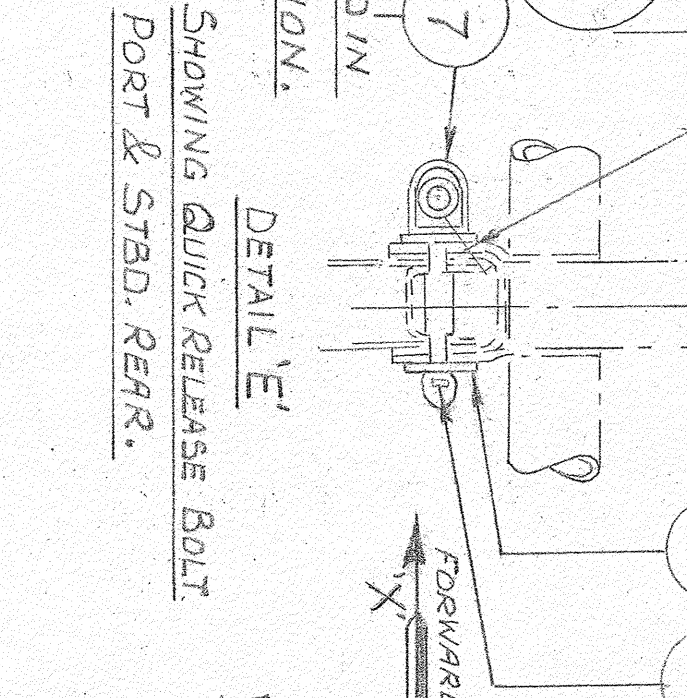
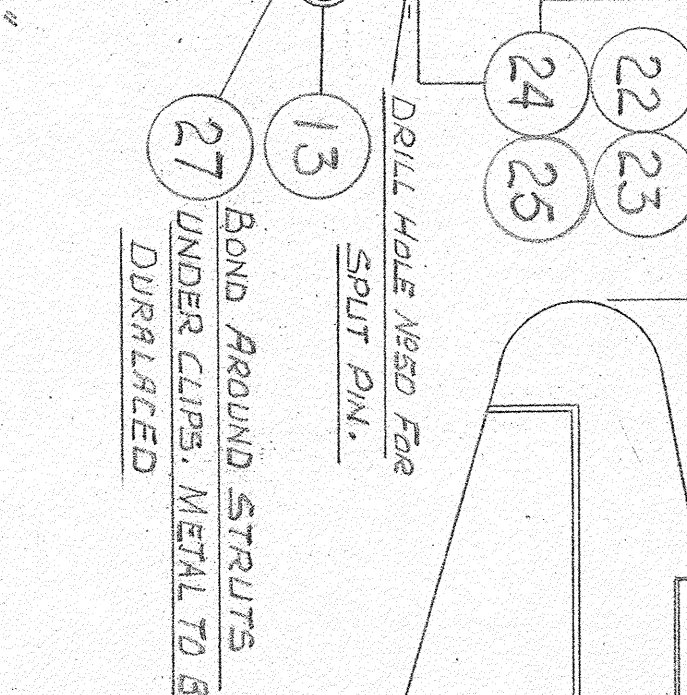
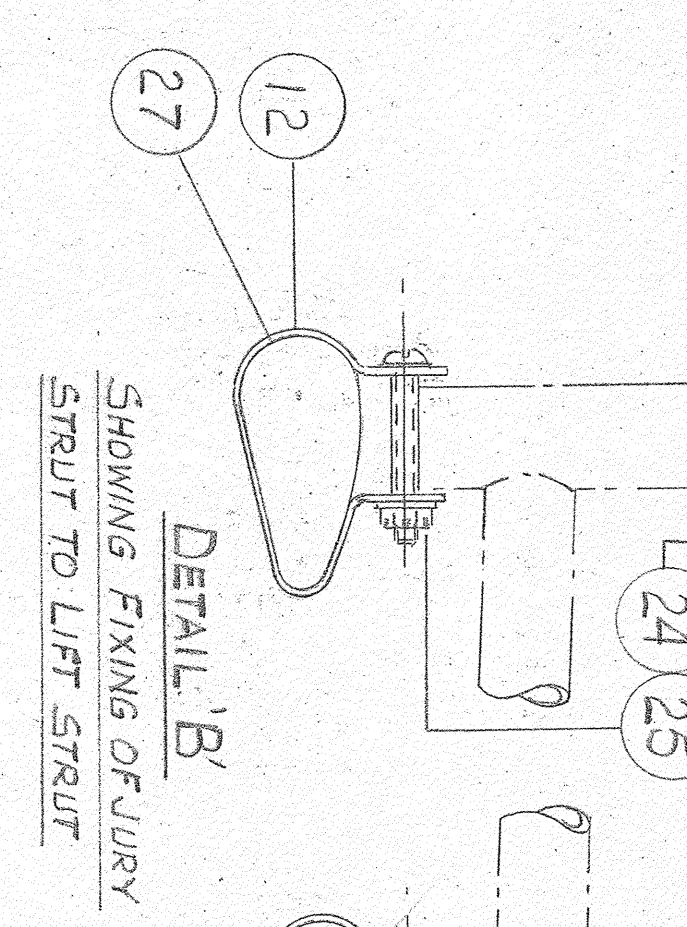
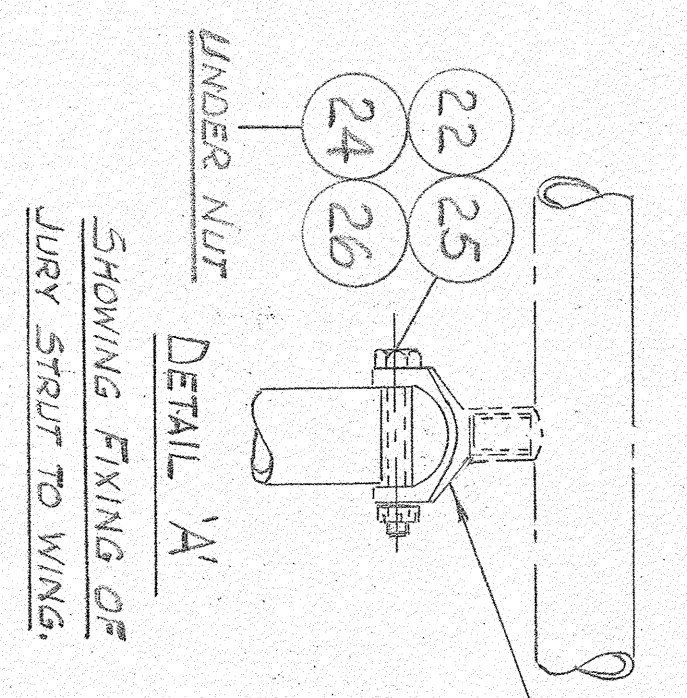
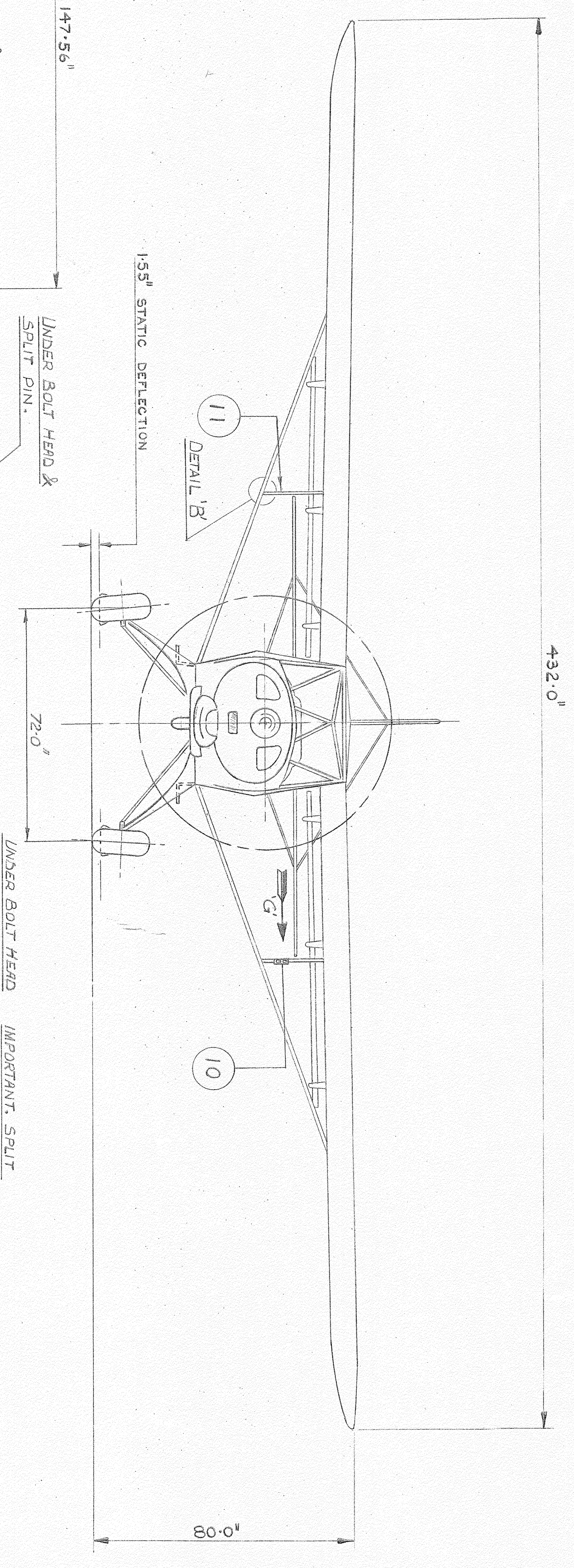
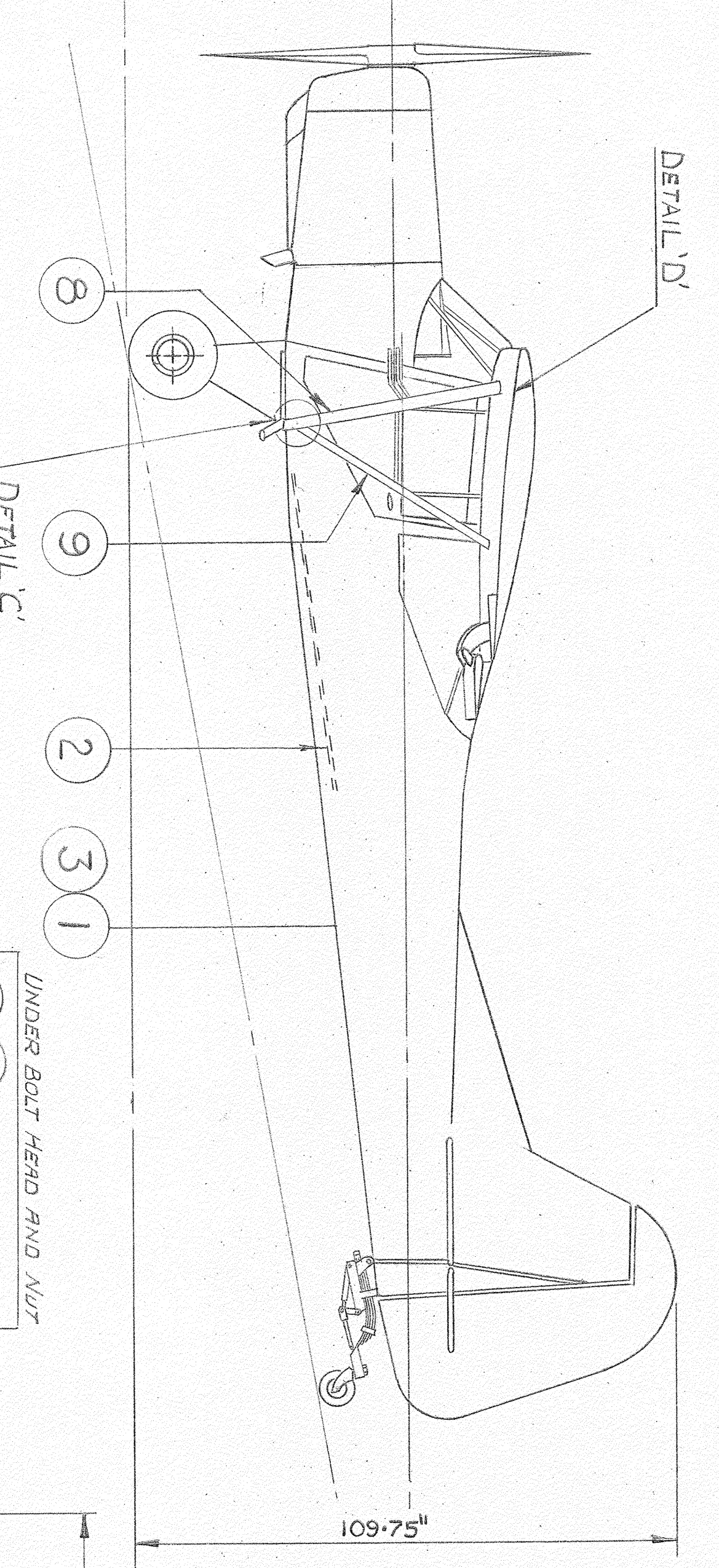

NO.	DESCRIPTION	QTY	UNIT	REMARKS
18	UNDER NUT	1	EA	
22	WASHER	2	EA	
23	WASHER	2	EA	
24	WASHER	2	EA	
25	WASHER	2	EA	
26	WASHER	2	EA	
27	WASHER	2	EA	
28	WASHER	2	EA	
29	WASHER	2	EA	
30	WASHER	2	EA	
31	WASHER	2	EA	
32	WASHER	2	EA	
33	WASHER	2	EA	
34	WASHER	2	EA	
35	WASHER	2	EA	
36	WASHER	2	EA	
37	WASHER	2	EA	
42	WASHER	2	EA	
43	WASHER	2	EA	
44	WASHER	2	EA	

SHOWING CONNECTION OF FLAP CONTROL ROD TO FLAP.

SHOWING FIXING OF LIFT STRUTS TO WING. NOTE: LIFT STRUT FITTINGS ON SPARS MUST NOT BE DISTURBED BY OVERTIGHTENING OF BOLTS.

SHOWING CONNECTIONS FOR PIVOT LINES IN WING TO PIVOT LINES ON JURY STRUT.

DIAGRAMMATIC SECTION 'H-H'.

GENERAL NOTES:
1. FOR RIGGING DIAGRAM SEE DRAWING CU 220 P/W JL 0331.
2. FOR LANDING & CG DIAGRAM SEE D3-00-001.

BEAGLE AIRCRAFT LIMITED LEICESTER.
TITLE: 3 VIEW GA-1 A61 SERIES 3.

NO.	DESCRIPTION	QTY	UNIT	REMARKS
1	WASHER	2	EA	
2	WASHER	2	EA	
3	WASHER	2	EA	
4	WASHER	2	EA	
5	WASHER	2	EA	
6	WASHER	2	EA	
7	WASHER	2	EA	
8	WASHER	2	EA	
9	WASHER	2	EA	
10	WASHER	2	EA	
11	WASHER	2	EA	
12	WASHER	2	EA	
13	WASHER	2	EA	
14	WASHER	2	EA	
15	WASHER	2	EA	
16	WASHER	2	EA	
17	WASHER	2	EA	
18	WASHER	2	EA	
19	WASHER	2	EA	
20	WASHER	2	EA	
21	WASHER	2	EA	
22	WASHER	2	EA	
23	WASHER	2	EA	
24	WASHER	2	EA	
25	WASHER	2	EA	
26	WASHER	2	EA	
27	WASHER	2	EA	
28	WASHER	2	EA	
29	WASHER	2	EA	
30	WASHER	2	EA	
31	WASHER	2	EA	
32	WASHER	2	EA	
33	WASHER	2	EA	
34	WASHER	2	EA	
35	WASHER	2	EA	
36	WASHER	2	EA	
37	WASHER	2	EA	
42	WASHER	2	EA	
43	WASHER	2	EA	
44	WASHER	2	EA	