

- DO NOT SCALE DRAWING.
- ENGLISH PROJECTION IS USED UNLESS OTHERWISE STATED.
- TOLERANCES ON DIMENSIONS ARE + OR - .01 UNLESS OTHERWISE STATED.
- IF IN DOUBT ABOUT THIS DRAWING, RING DRAWING OFFICE BEFORE COMMENCING OPERATIONS.

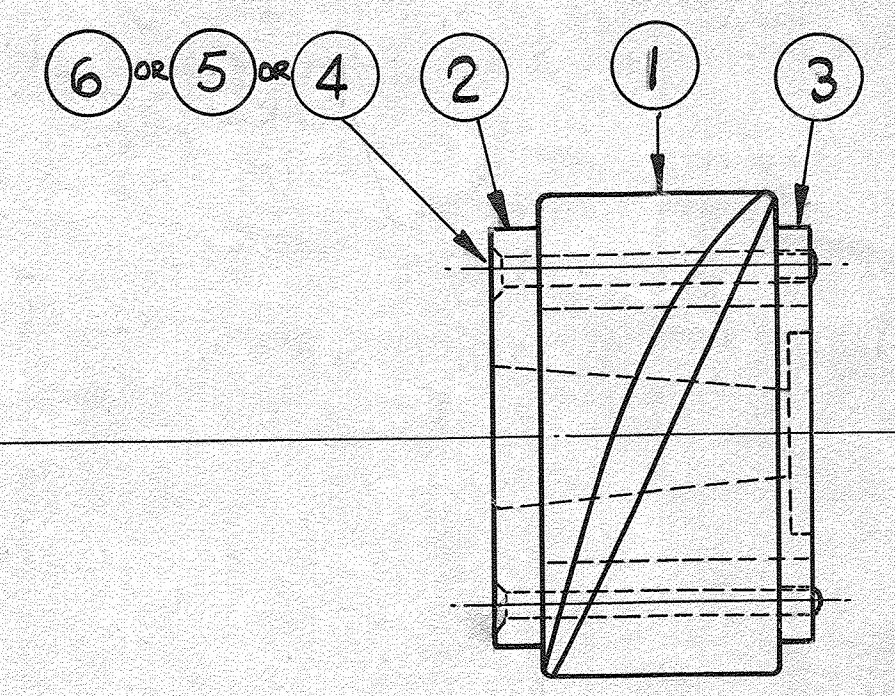
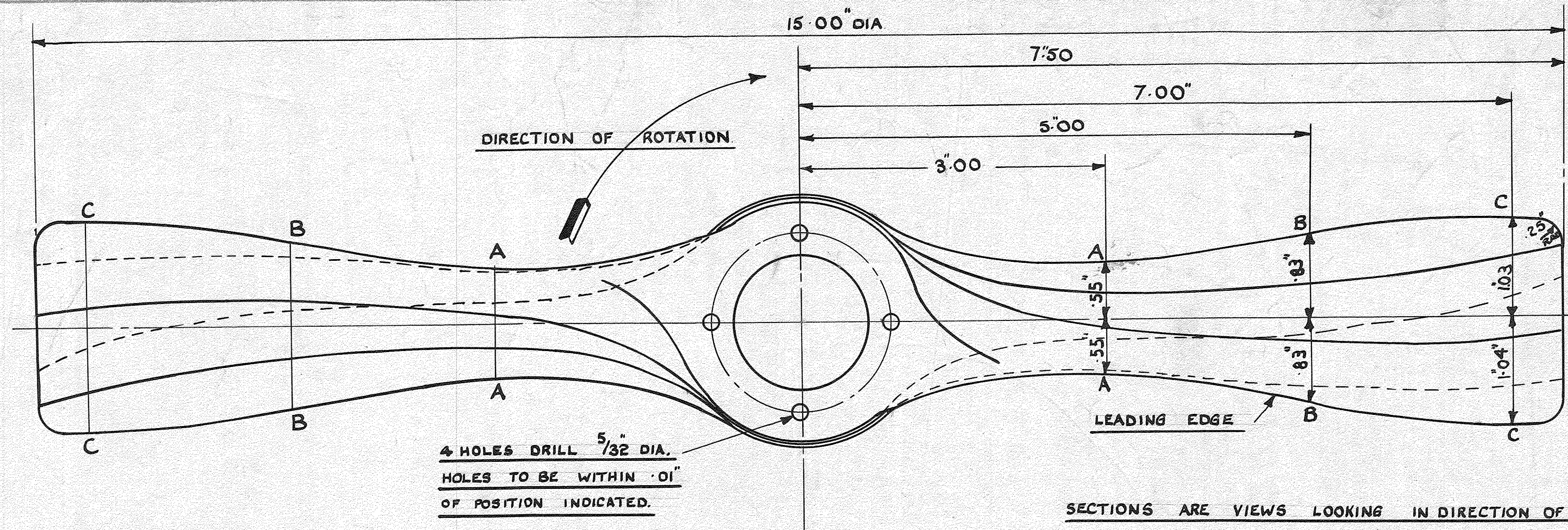

SECTIONS ARE VIEWS LOOKING IN DIRECTION OF ARROW.

THE FOLLOWING PARTICULARS TO BE MARKED ON THE ROUND OF THE BOSS

DRG T29117 (AND CURRENT ISSUE NO. OF DRG) SERIAL NO.

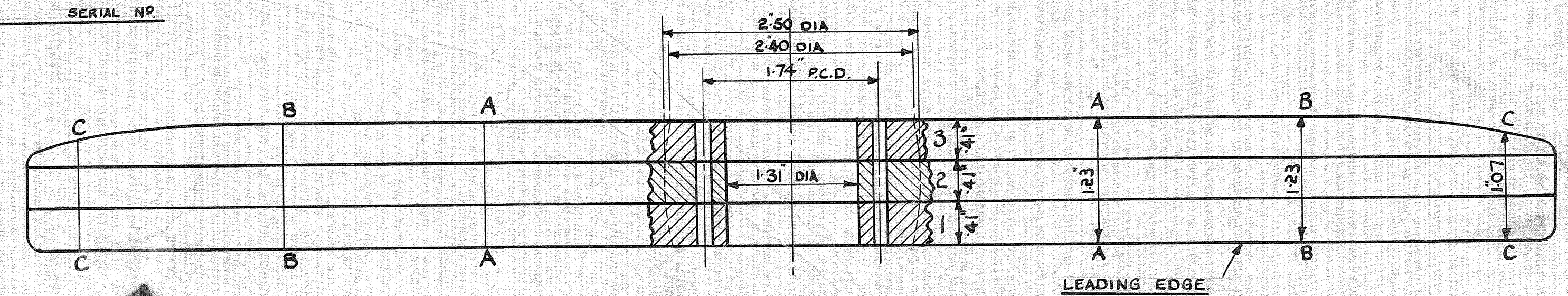

WINDMILLS MANUFACTURED TO THIS DRAWING TO BE IN ACCORDANCE WITH SPECIFICATION D.T.D. 1001.

THE ERROR IN STATIC BALANCE OBSERVED FOR THE FINISHED WINDMILL IN THE PLANE OF ROTATION, ADDED TO THE ERROR DUE TO THE LACK OF SENSITIVITY OF THE BALANCING APPARATUS MUST NOT EXCEED 2.0 INCH GRAMS WITH THE WINDMILL VERTICAL AND 1.0 INCH GRAM WITH THE WINDMILL HORIZONTAL.

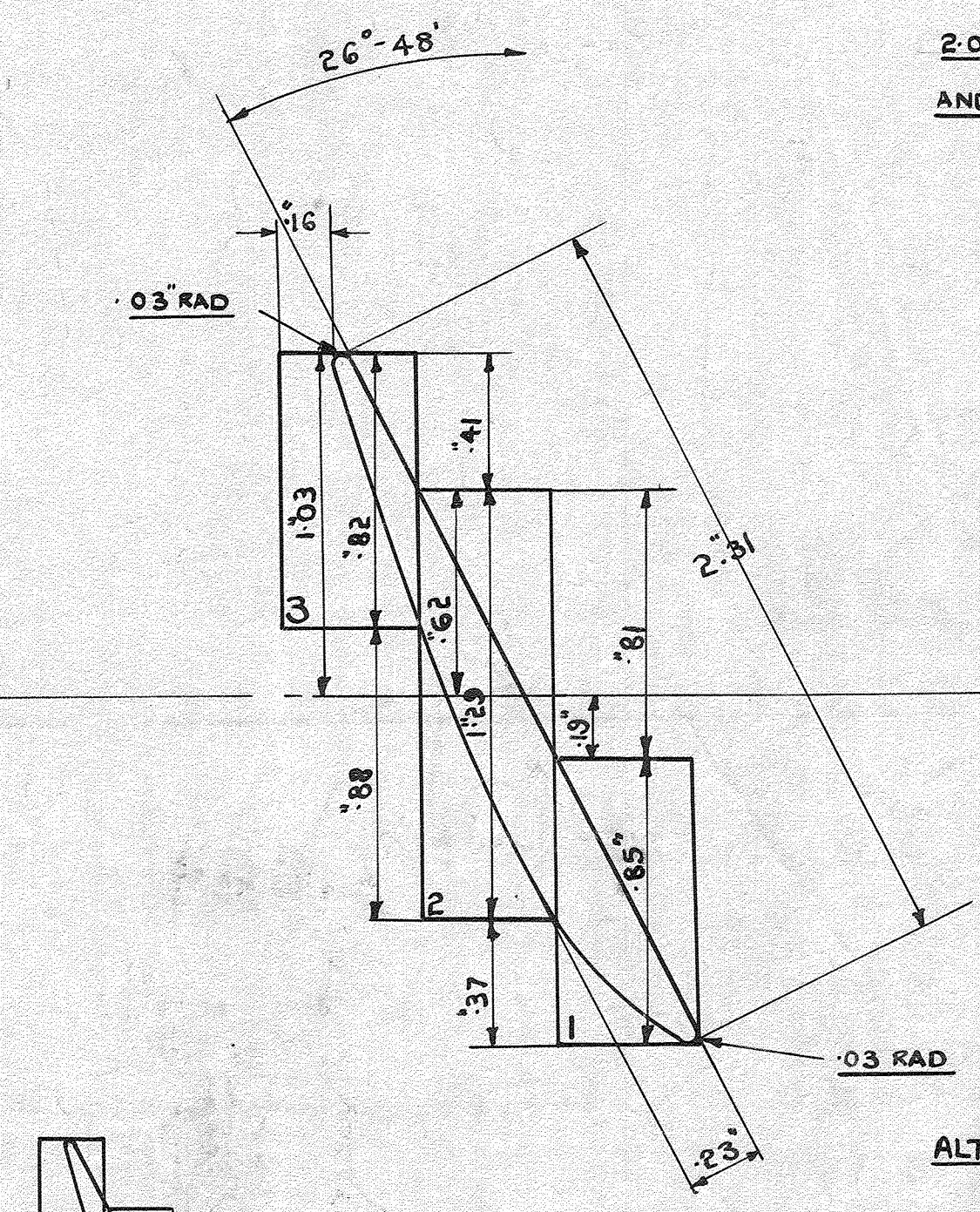
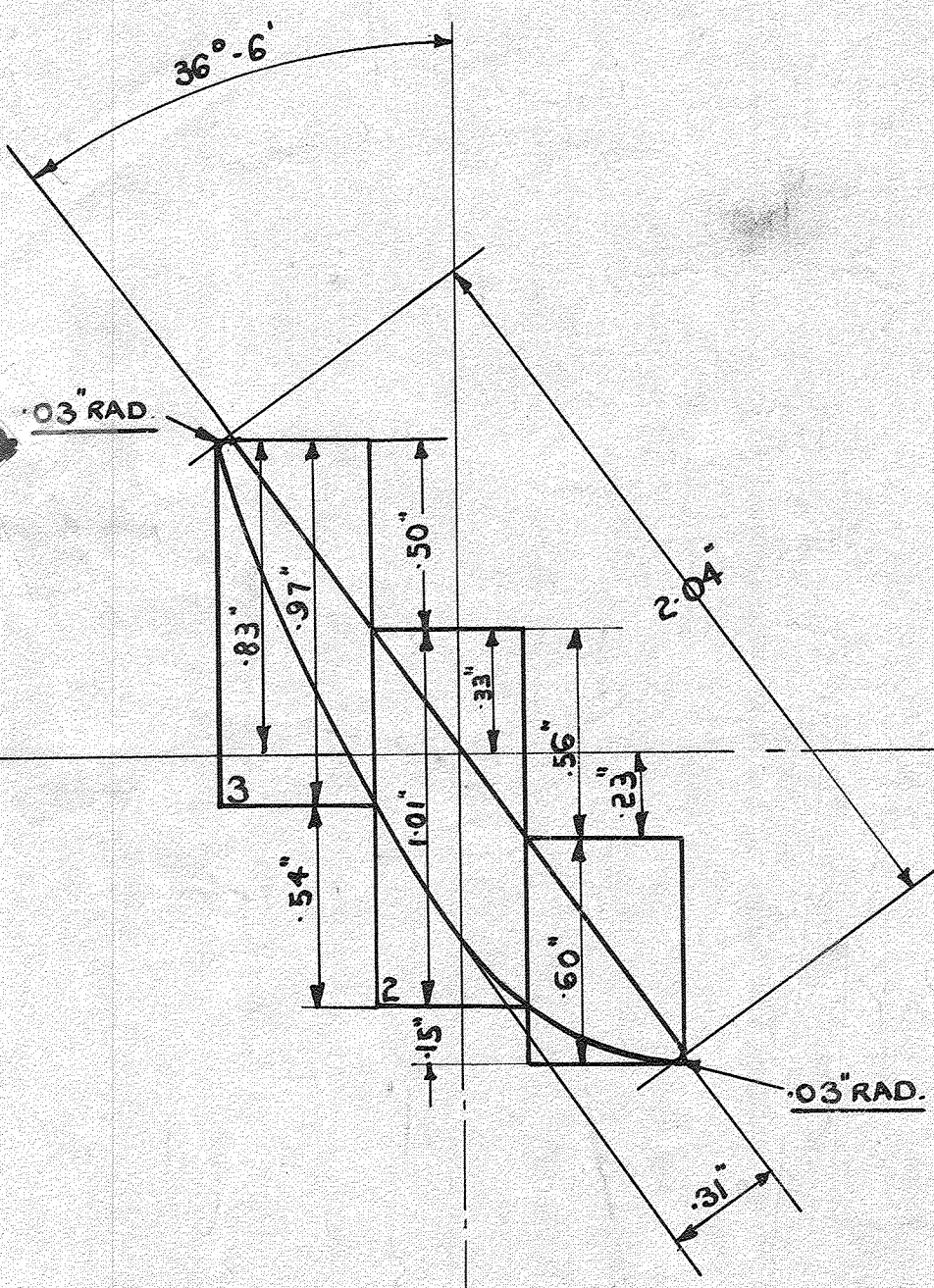
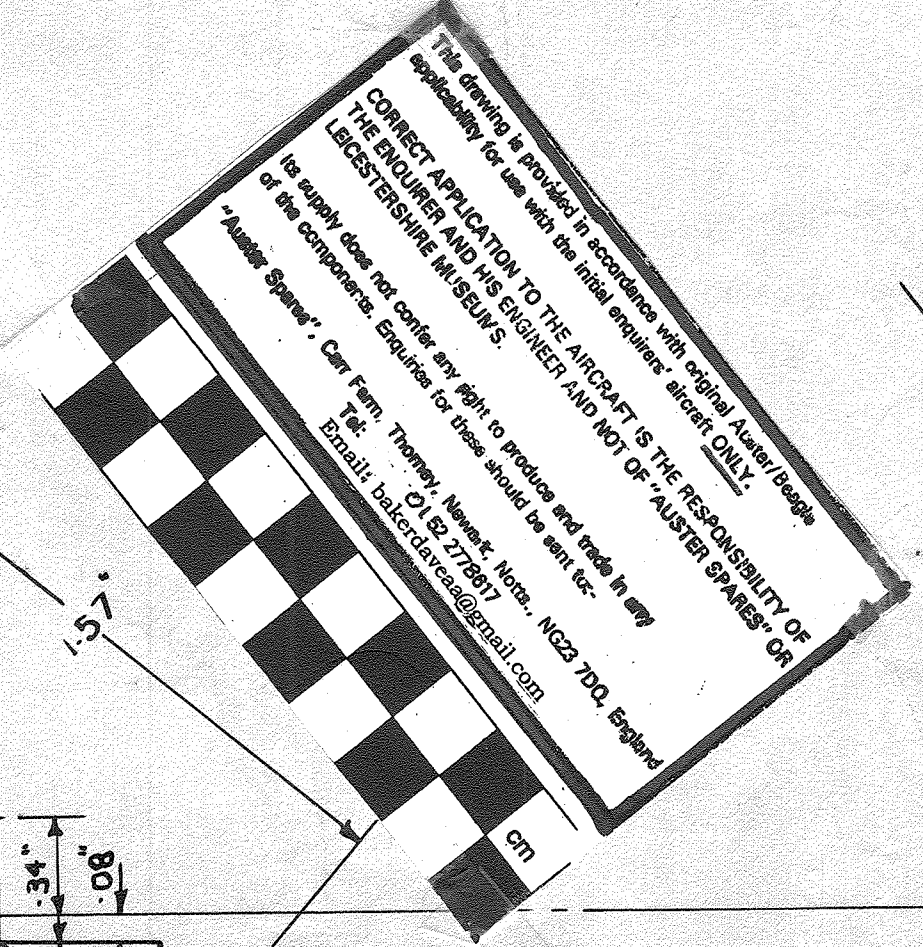
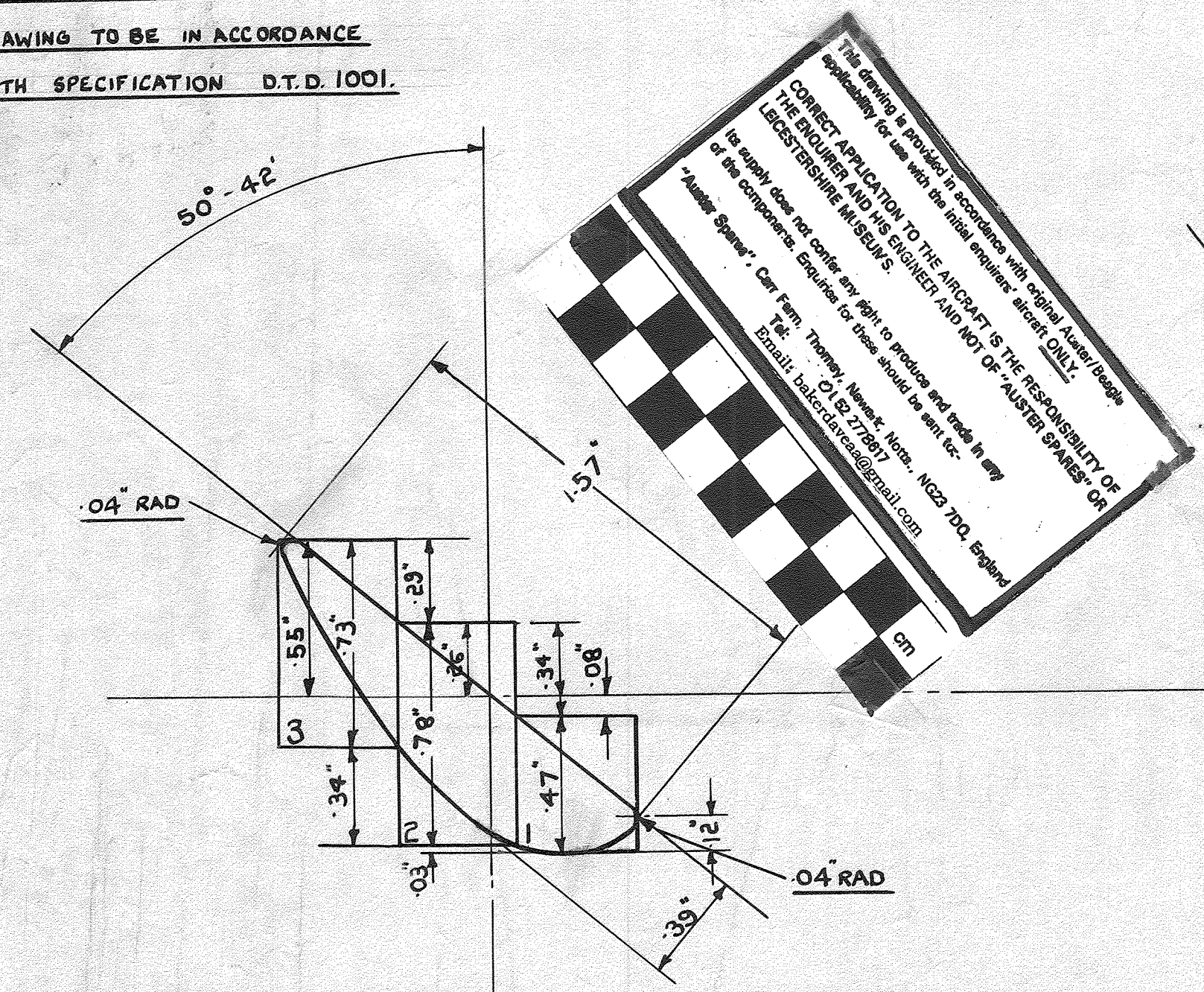

MATERIAL-MAHOGANY.

C	CIVIL AMEND	2240			
B	CIVIL AMEND	2025			
A	CIVIL MOD.	1761			
ISSUE	NO.	INTERNAL MOD. NO.	CLASS	APP	RTO
TYPE: J/1, J/4, J/5, AUSTER 4&5					

SECTION A.A.

SECTION B.B.

SECTION C.C.

ALTERNATIVES

10					
9					
8					
7					
6	AS 1242/148	BOLT			4
5	AS 249/-	4BA. SCREW C/SK x 1 3/4" long			4
4	AS 1882/148	BOLT			4
3	J 74733	RING	AJK 325		1
2	J 74732	BOSS	AJK 324		1
1	J 74734	WINDMILL	MAHOGANY		1

PROTECTIVE TREATMENT	ASSY. Nos. FJK 465	ITEM No.	PART No.	DESCRIPTION	MATERIAL OR DRG. No.	No. OFF
SCALE: FULL & TWICE FULL SIZE		DRAWN: F. SWIFT.	CHECKED: R.A.E.	TAYLORCRAFT AEROPLANES (ENGLAND) LTD., LEICESTER.	PART NO JA 73193	
TITLE: WINDMILL FOR TWO-PURPOSE GENERATOR				APPROVED: R.A.E.	DRG. NO. DJK 268	